



Anatomische Pinzetten  
Dressing Forceps

cm	Standard	schmal narrow	TC
10,5	01E-249	01E-274	
11,5	01E-250	01E-275	
13,0	01E-001	01E-276	01E-305
14,5	01E-002	01E-277	01E-306
15,0	01E-251	01E-278	
16,0	01E-003	01E-279	01E-307
18,0	01E-252	01E-280	01E-308
20,0	01E-004	01E-281	01E-309
25,0	01E-005	01E-282	01E-310
30,0	01E-253	01E-283	



Chirurgische Pinzetten  
Tissue Forceps

cm	schmal narrow				
	1:2	1:2	2:3	3:4	4:5
10,5	01E-255				
11,5	01E-246	01E-284	01E-318		
13,0	01E-256	01E-285	01E-319	01E-326	01E-331
14,5	01E-006	01E-286	01E-320	01E-327	01E-332
15,0	01E-257				
16,0	01E-247	01E-287	01E-321	01E-328	01E-333
18,0	01E-258	01E-288	01E-322	01E-329	01E-334
20,0	01E-259	01E-289	01E-323	01E-330	01E-335
25,0	01E-260	01E-290	01E-324		
30,0	01E-261	01E-291	01E-325		



Adson anatomische Pinzetten  
Adson Dressing Forceps

cm		Mikro	TC
12,0	01E-007	01E-007.05	01E-311
15,0	01E-007.02	01E-007.06	01E-312



cm	Potts-Smith	Potts-Smith 1:2	Potts-Smith TC
18,0	01E-297	01E-300	01E-315
21,0	01E-298	01E-301	01E-316
25,0	01E-299	01E-302	01E-317



cm Gerald  
18,0



01E-460.01



01E-460.02



01E-461.01



01E-461.02

cm 1:2  
Gillies  
15,0 01E-303





Adson Chirurgische Pinzetten  
Adson Tissue Forceps

cm		Mikro
12,0	01E-008	01E-008.05
15,0	01E-008.02	01E-008.06



Adson  
Brown  
01E-254  
01E-254.02



cm	Semken	Semken 1:2
12,5	01E-292	01E-294
15,0		
15,5	01E-293	01E-295



McIndoe  
01E-296

**Feine Pinzetten**  
**Fine Forceps**

cm	
8,0	01E-371
9,0	01E-372
10,5	01E-373
11,5	01E-374
12,5	01E-375
14,5	01E-376

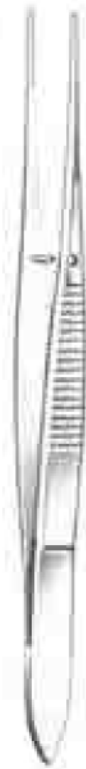
 10,0 cm  
22E-068

 10,0 cm  
22E-071

 10,0 cm  
22E-077

 10,0 cm  
22E-080

**Uhrmacherpinzetten**  
**Watchmaker's Forceps**

 No. 3  
11,5 cm  
01E-465.03

 No. 4  
11,5 cm  
01E-465.04

 No. 5  
11,5 cm  
01E-465.05

 No. 7  
11,5 cm  
01E-465.07

**01E-014** Feilchenfeld Splitterpinzette,  
9 cm

Feilchenfeld Splitter  
Forceps, 3 1/2"

**01E-015** Feilchenfeld Splitterpinzette,  
11,5 cm

Feilchenfeld Splitter  
Forceps, 4 1/2"

**01E-016** Stieglitz Splitterpinzette,  
gerade, 14,0 cm

Stieglitz Splitter Forceps  
straight, 5 1/2"

**01E-017** Stieglitz Splitterpinzette,  
gebogen, 14,0 cm

Stieglitz Splitter Forceps  
curved, 5 1/2"

**01E-018** Ralk Splitterzange,  
gerade, 15,0 cm

Ralk Splitter Forceps,  
straight, 6"

**01E-019** Ralk Splitterzange,  
gebogen, 15,0 cm

Ralk Splitter Forceps,  
curved, 6"



01E-014/015

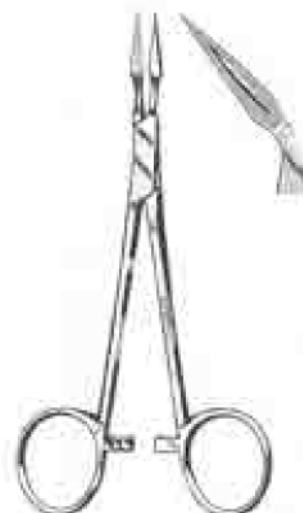

01E-016

01E-017



01E-018 / 01E-019



Delbakoy Adams  
 23E-027 19,0 cm



Delbakoy



	1,5 mm	2,0 mm	2,4 mm	2,7 mm	3,5 mm
16 cm	23E-028	23E-032	23E-044	23E-048	23E-052
20 cm	23E-029	23E-033	23E-045	23E-049	23E-053
24 cm	23E-030	23E-034	23E-046	23E-050	23E-054
30 cm	23E-031	23E-035	23E-047	23E-051	23E-055



	2,0 mm	3,5 mm
16 cm	23E-036	23E-040
20 cm	23E-037	23E-041
24 cm	23E-038	23E-042
30 cm	23E-039	23E-043

Arterienklemmen  
Hemostatic Forceps

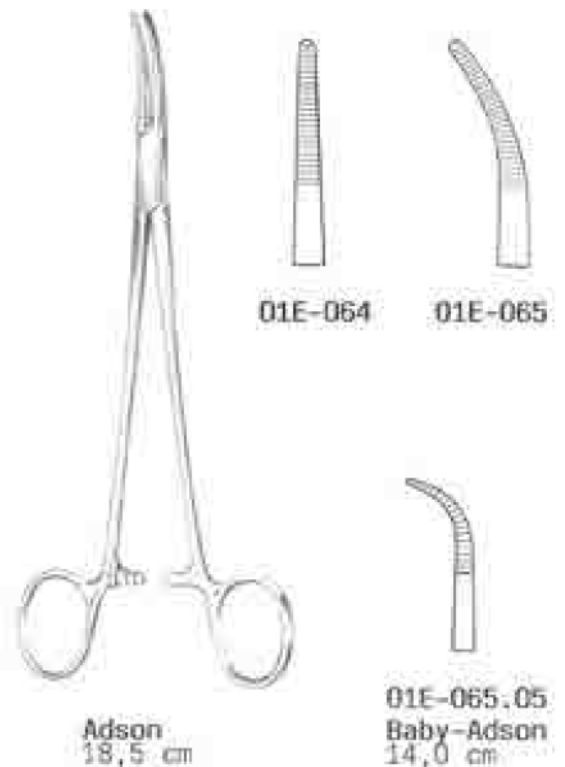
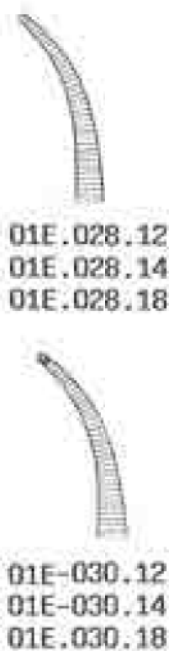
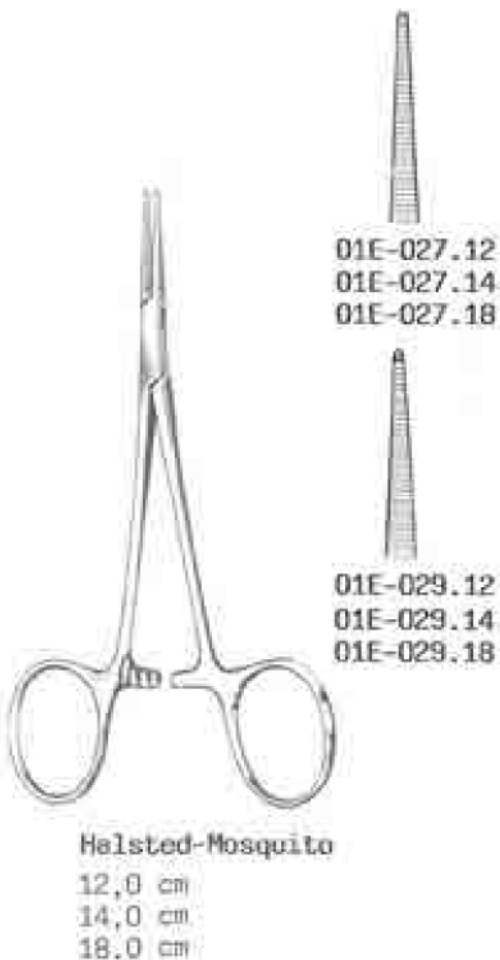
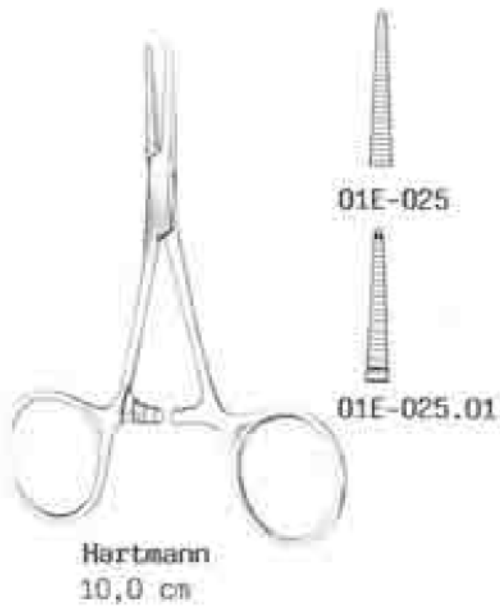

Arterienklemmen  
Hemostatic Forceps



Providence  
14,0 cm



01E-031



01E-032

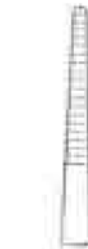

01E-033



01E-034

Kelly  
14,0 cm



01E-042



01E-043

Kelly-  
Rankin  
16,0 cm



01E-035



01E-036

Crile  
14,0 cm



01E-035.01



01E-036.01

Crile  
1:2  
14,0 cm



01E-044



01E-045

Crile-  
Rankin  
16,0 cm



01E-044.01



01E-045.01

Crile-  
Rankin  
1:2  
16,0 cm



Arterienklemmen  
Hemostatic Forceps

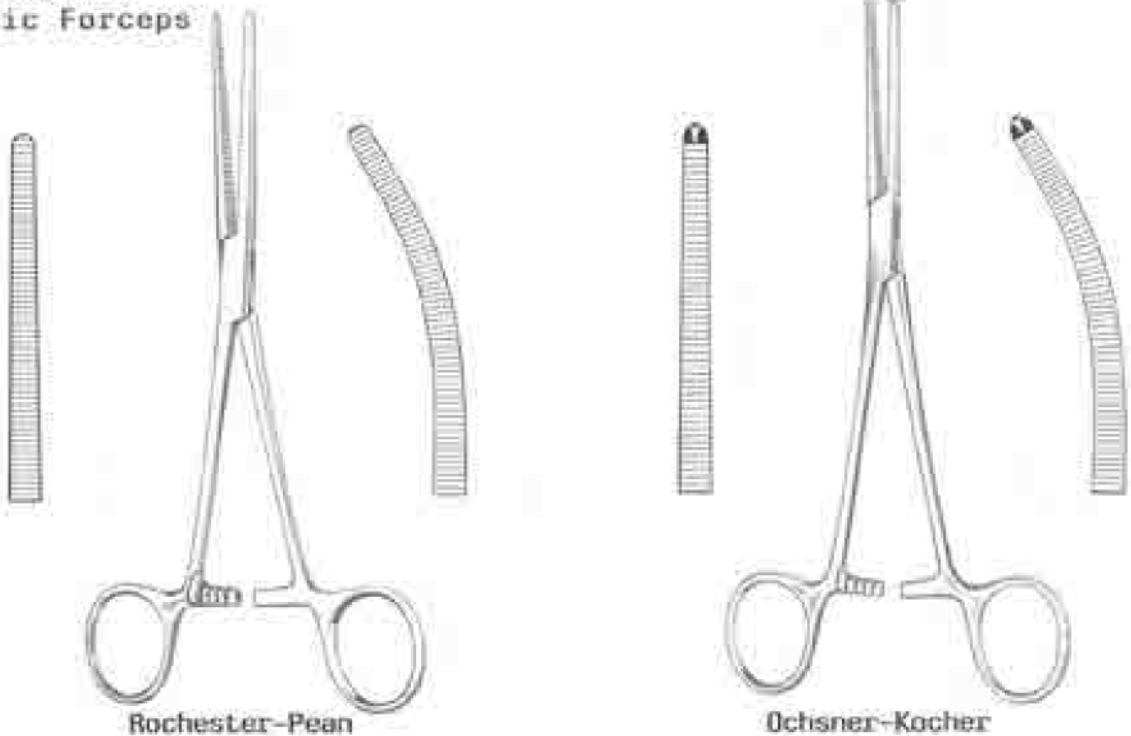

Rochester-Pean

Ochsner-Kocher

cm

13,0	01E-393	01E-394	01E-395	01E-396
14,0	01E-052	01E-058	01E-074	01E-080
16,0	01E-053	01E-059	01E-075	01E-081
18,0	01E-054	01E-060	01E-076	01E-082
20,0	01E-055	01E-061	01E-077	01E-083
22,0	01E-056	01E-062	01E-078	01E-084
26,0	01E-057	01E-063	01E-079	01E-085



Leriche  
15,0 cm

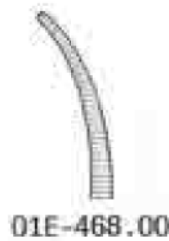

Baby-Overholt  
13,5 cm

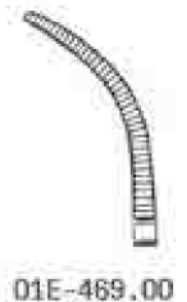

**Arterienklemmen**  
**Hemostatic Forceps**

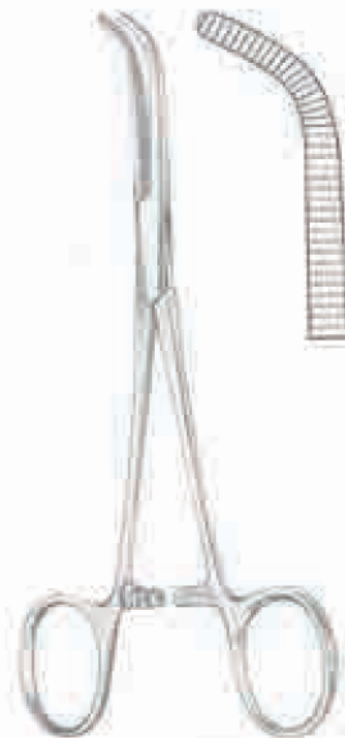
**Baby-Mixer**  
 14,0 cm 08E-009.14  
 18,0 cm 08E-009.18

**Mixer D'Shaugnessy**  
 15,5 cm 08E-007.15  
 19,0 cm 08E-007.19

**Tuchklemmen**  
**Towel Forceps**

**Jones**  
 5,0 cm 01E-099.05  
 9,0 cm 01E-099.09

**Schüdel**  
 9,0 cm  
 01E-470.09

**Backhaus**  
 9,0 cm 01E-094  
 11,0 cm 01E-095  
 13,0 cm 01E-096



01E-606.01

Joseph 15,5 cm



2 mm  
01E-606.02



5 mm  
01E-606.05



7 mm  
01E-606.07



10 mm  
01E-606.10



Joseph 16,5 cm

Wundhaken  
Retractors



16 cm



flexibel  
flexible



16 cm



scharf  
sharp

stumpf  
blunt



Senn-Miller  
16 cm



01E-108

scharf  
sharp



01E-109

stumpf  
blunt



Mini-Langenbeck  
16 cm



01E-631.10  
10 x 6 mm



01E-631.20  
20 x 6 mm



01E-631.17  
17 x 5 mm



01E-631.22  
22 x 8 mm

Wundhaken  
Retractors

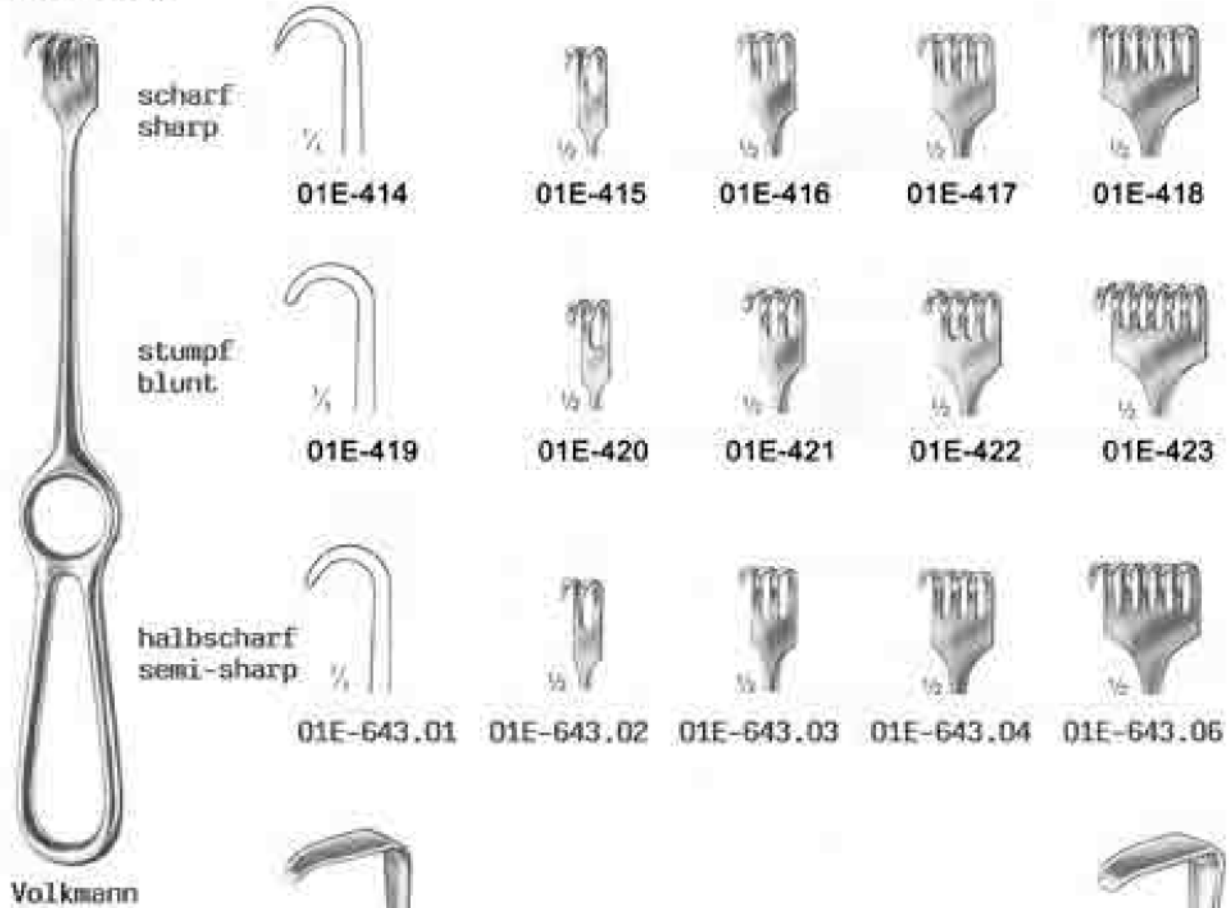

Langenbeck 22 cm	mm	Langenbeck 21 cm
01E-660.01	30 x 11	01E-661.01
01E-660.02	30 x 14	01E-661.02
01E-660.03	30 x 16	01E-661.03
01E-660.04	40 x 11	01E-661.04
01E-660.05	50 x 11	01E-661.05
	60 x 20	01E-661.06
	85 x 15	01E-661.07



Wundhaken  
Retractors

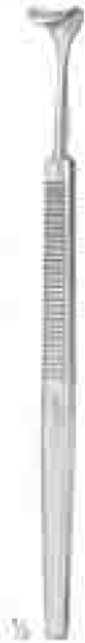

Desmarres  
16 cm



01E-628.12  
12 mm



01E-628.14  
14 mm



01E-628.16  
16 mm



01E-628.18  
18 mm



Farabeuf



Satz  
Set

01E-105  
12 cm

01E-106  
15 cm



Roux

Satz  
Set

01E-413

Fig.1 14 cm  
01E-410

Fig.2 15 cm  
01E-411

Fig.3 17 cm  
01E-412



Baby-Roux  
01E-410.13  
13 cm



Kocher  
19 cm

01E-668.01  
19 x 12 mm

01E-668.02  
21 x 15 mm

Wundhaken, Mundsperrer  
Retractors



Kocher-Langenbeck  
21,0 cm

mm		
25 x 8		01E-664.01
35 x 8		01E-664.02
35 x 11		01E-664.03
35 x 15		01E-664.04
40 x 11		01E-664.05
55 x 11		01E-664.06
70 x 14		01E-664.07
80 x 12		01E-664.08
80 x 16		01E-664.09



Alm

	scharf sharp	stumpf blunt
7 cm	01E-735.07	01E-736.07
10 cm	01E-735.10	01E-736.10



01E-750.10  
10 cm



Jansen

cm	scharf sharp	stumpf blunt
10,5	01E-752.10	01E-753.10
13,0		
16,5		



Weitlaner

cm	scharf sharp	stumpf blunt
	01E-428	01E-429



Weitlaner

cm	scharf sharp	stumpf blunt
	01E-110	01E-111
	01E-481	01E-480

Wundsperrer  
Retractors

Weitlaner-Wullstein		
	scharf	stumpf
cm	sharp	blunt
13	01E-770.13	01E-771.13



Mollison	
01E-777.15	15 cm



Plester		
	scharf	stumpf
cm	sharp	blunt
13	01E-772.13	01E-773.13



Plester	
01E-774.11	11 cm



Plester	
01E-775.11	11 cm



Baby-Adson		
	scharf	stumpf
cm	sharp	blunt
13,0	01E-785.13	01E-786.13
16,5	01E-785.16	01E-786.16



G O S S E T

Bauchdeckenhalter  
Abdominal Retractors



01E-112 40 mm x 90 mm  
01E-113 63 mm x 160 mm

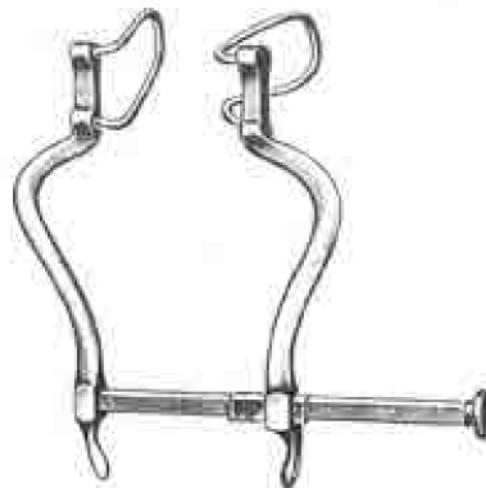

01E-270 60 mm x 140 mm

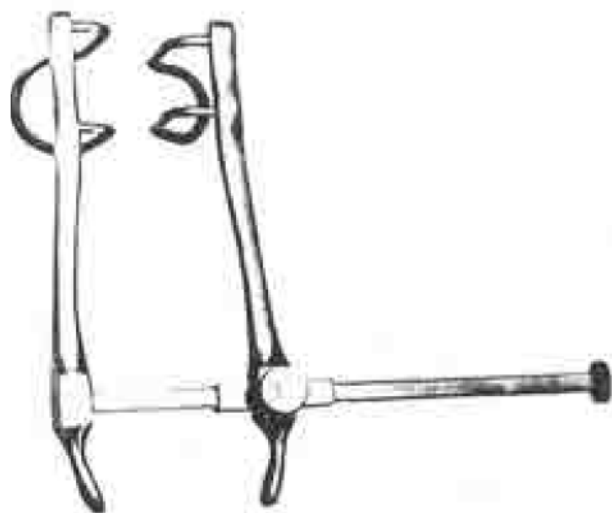

01E-271 40 mm x 90 mm  
mit Feststellschraube  
with fixing screw

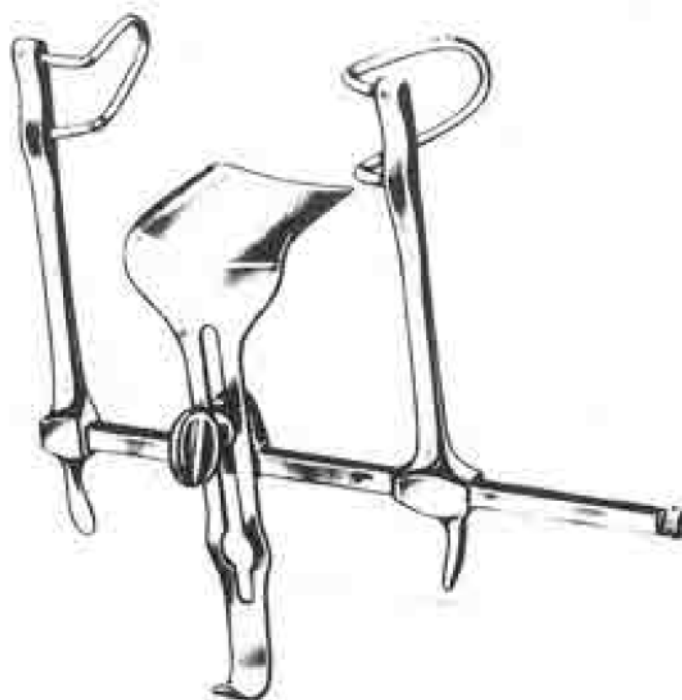

01E-430 63 mm x 160 mm  
mit Mittelblatt  
with centre blade

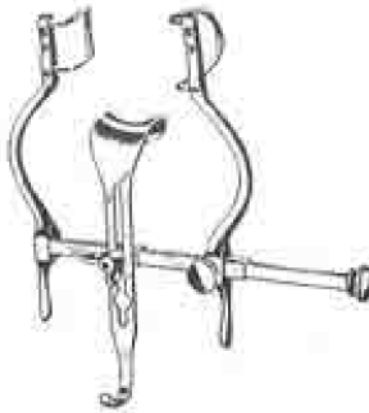

<b>01E-431</b>	Spreizweite	90 mm
	Blade opening	90 mm
	Valventiefe	27 mm
	Deep of Valves	27 mm

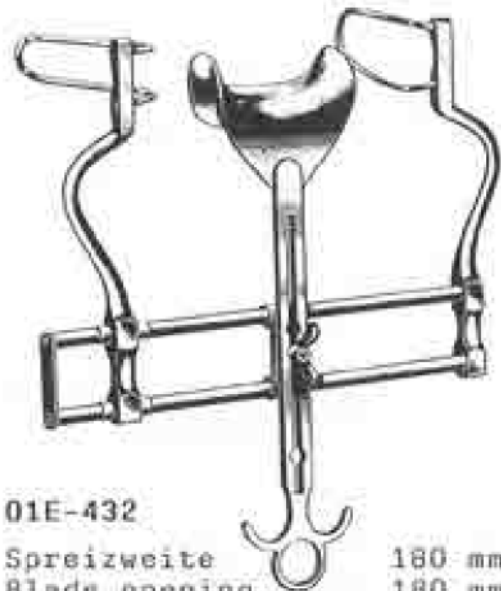

<b>01E-432</b>	Spreizweite	180 mm
	Blade opening	180 mm
	Valventiefe	63 mm
	Deep of Valves	63 mm

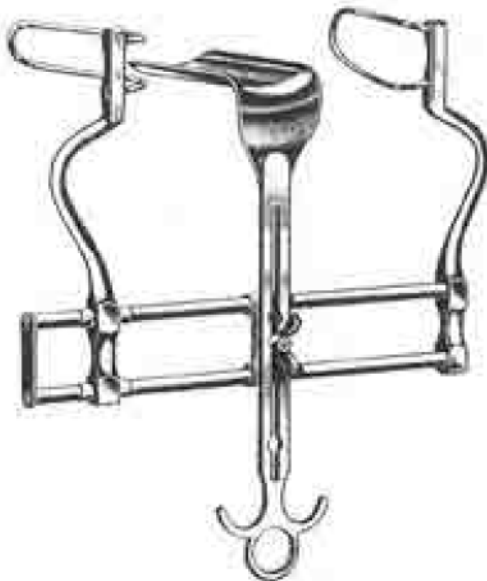

<b>01E-433</b>	Spreizweite	200 mm
	Blade opening	200 mm
	Valventiefe	100 mm
	Deep of Valves	100 mm

**01E-436**  
Mittelblatt allein, 24 mm x 20 mm  
für 01E-431  
Centre blade only, 24 mm x 20 mm  
for 01E-431

**01E-437**  
Mittelblatt allein, 45 mm x 80 mm  
für 01E-432  
Centre blade only, 45 mm x 80 mm  
for 01E-432

**01E-438**  
Mittelblatt allein, 70 mm x 100 mm  
für 01E-433  
Centre blade only, 70 mm x 100 mm  
for 01E-433

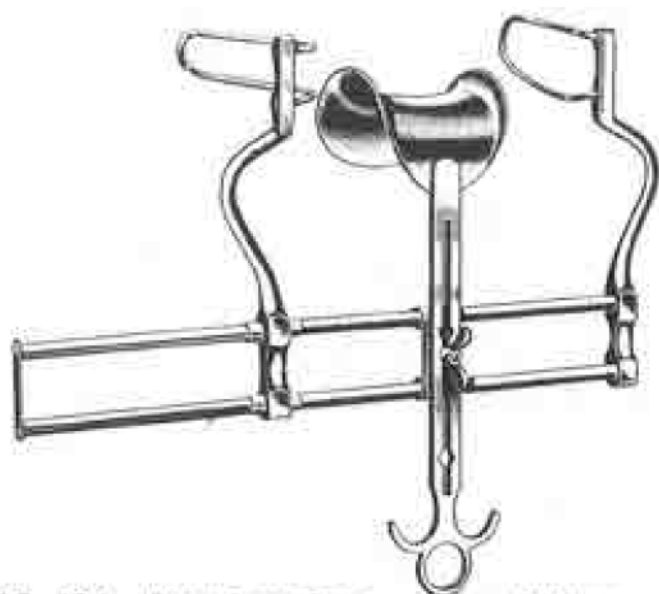

<b>01E-434</b>	Spreizweite	250 mm
	Blade opening	250 mm
	Valventiefe	100 mm
	Deep of Valves	100 mm

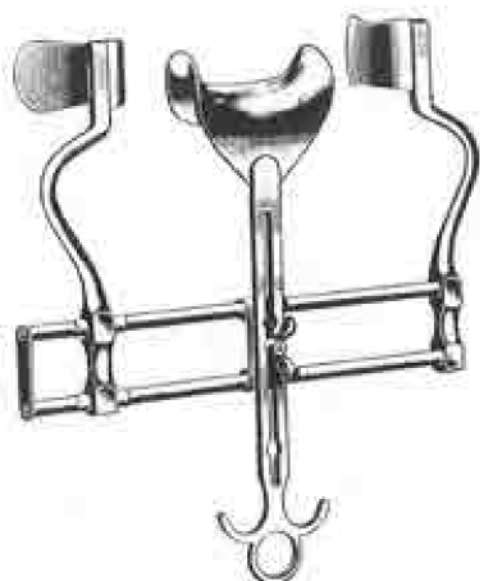

<b>01E-435</b>	Spreizweite	180 mm
	Blade opening	180 mm
	Valventiefe	70 mm
	Deep of Valves	70 mm

**01E-439**  
Mittelblatt allein, 70 mm x 85 mm  
für 01E-434  
Centre blade only, 70 mm x 85 mm  
for 01E-434

**01E-437**  
Mittelblatt allein, 45 mm x 80 mm  
für 01E-435  
Centre blade only, 45 mm x 80 mm  
for 01E-435

Sonden  
Probes



cm	φ 1 mm NR SS	φ 1,5mm NR SS	φ 2 mm NR SS	φ 2 mm Silber Silver
11,5	01E-117	01E-125	01E-133	01E-141
13,0	01E-118	01E-126	01E-134	01E-142
14,5	01E-119	01E-127	01E-135	01E-143
16,0	01E-120	01E-128	01E-136	01E-144
18,0	01E-121	01E-129	01E-137	01E-145
20,0	01E-122	01E-130	01E-138	01E-146
25,0	01E-123	01E-131	01E-139	01E-147
30,0	01E-124	01E-132	01E-140	01E-148

cm	φ 2 mm NR SS	φ 2 mm Silber Silver
11,5	01E-149	01E-157
13,0	01E-150	01E-158
14,5	01E-151	01E-159
16,0	01E-152	01E-160
18,0	01E-153	01E-161
20,0	01E-154	01E-162
25,0	01E-155	01E-163
30,0	01E-156	01E-164



φ 1 mm  
10,5 cm  
NR  
SS  
01E-171.02  
  
Silber  
Silver  
01E-171.04  
  
Neusilber  
German Silver  
01E-171.06  
  
Stacke

cm	01E-173	01E-177	01E-183	01E-188
11,5	01E-173	01E-177	01E-183	01E-188
13,0	01E-174	01E-178	01E-183	01E-188
14,5	01E-175	01E-179	01E-184	01E-188
16,0	01E-176	01E-180	01E-185	01E-188
18,0		01E-181	01E-186	01E-188
20,0		01E-182		01E-188

Sonden, Watteträger  
Probes, Cotton-Applicators



Bowman

Neusilber German Silver	Fig.	Silber Silver
01E-471.01	0000/000	01E-472.01
01E-471.02	000/00	01E-472.02
01E-471.03	00/0	01E-472.03
01E-471.04	0/1	01E-472.04
01E-471.05	1/2	01E-472.05
01E-471.06	2/3	01E-472.06
01E-471.07	3/4	01E-472.07
01E-471.08	4/5	01E-472.08
01E-471.09	5/6	01E-472.09
01E-471.10	6/7	01E-472.10
01E-471.11	7/8	01E-472.11



Piccolo

cm	∅ 0,8 mm	∅ 1,0 mm
12,0	01E-450	01E-455
14,0	01E-451	01E-456



Farrell

cm			
12,0	01E-195	01E-201	01E-207
14,0	01E-196	01E-202	01E-208
16,0	01E-197	01E-203	01E-209
18,0	01E-198	01E-204	01E-210
23,0	01E-199	01E-205	01E-211
24,0	01E-200	01E-206	01E-212



Universal

cm	∅ 1,2 mm	∅ 1,5 mm	∅ 1,8 mm
14,0	01E-233		01E-234
18,0		01E-235	01E-236



Graefe  
16.0 cm



scharf  
sharp  
01E-600.16



stumpf  
blunt  
01E-601.16



Emmet, 22.0 cm  
scharf / sharp



Fig. 1  
01E-602.01



Fig. 2  
01E-602.02



Fig. 3  
01E-602.03



Kilner, 15.0 cm  
scharf / sharp  
01E-603.15



Gillies, 18.0 cm  
scharf / sharp



Fig. 1  
01E-604.01



Fig. 2  
01E-604.02



Guthrie, 16.0 cm  
scharf / sharp



Fig. 1  
01E-605.01



Fig. 2  
01E-605.02



Iterson  
16.0 cm



Senn-Green  
15.0 cm



10 x 6 mm  
01E-622.10



20 x 6 mm  
01E-622.20